

**Gru a torre "Flat Top"**  
**"Flat Top" Tower Crane • Grue à tour "Flat Top"**  
**"Flat Top" Turmdrehkran • Grua torre "Flat Top"**

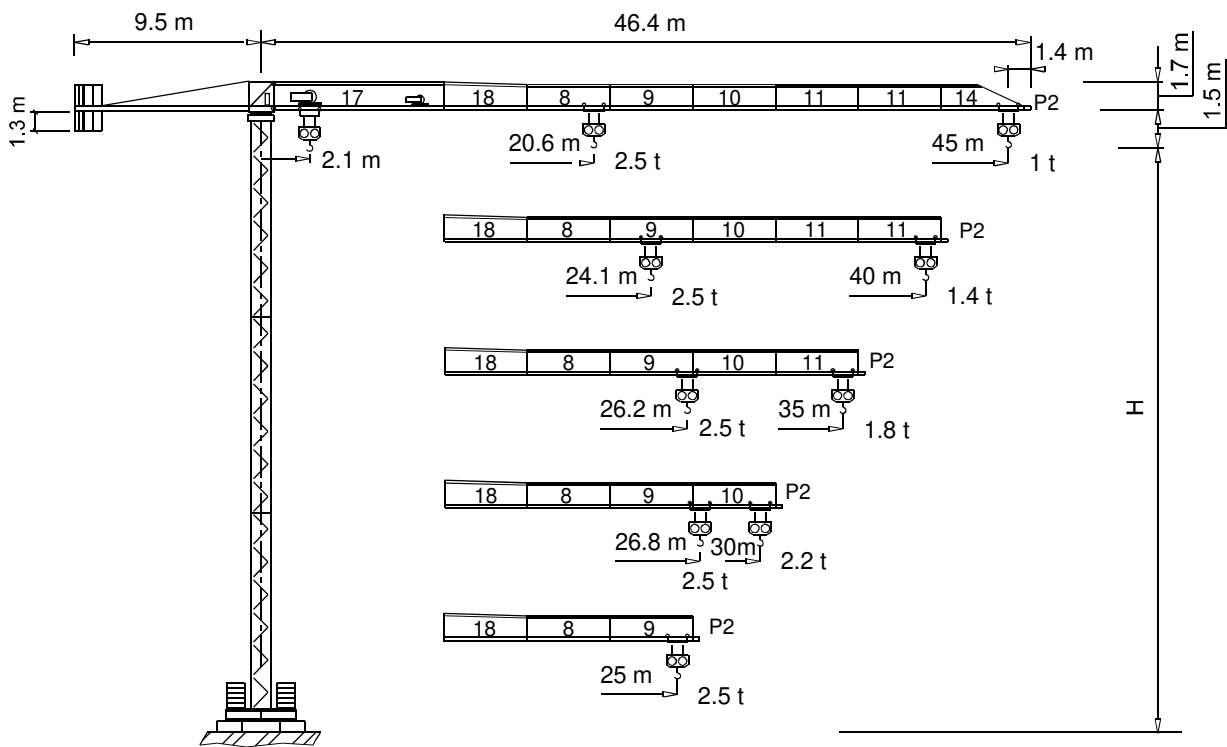

**CE FEM 1.001 A3**  
**(A2 )**

**THE ULTIMATE CRANE™**

Dati illustrativi non impegnativi  
 Con riserva di modifica senza preavviso

Specifications and data not binding  
 Subject to modification without notice

Données techniques seulement indicatives  
 Modifications réservées sans préavis

Angaben und Beschreibung unverbindlich  
 Änderungen vorbehalten ohne weitere Mitteilung

Dibujos y datos sin compromiso  
 Modificaciones reservadas sin preaviso

UTE.DOC.REV.000 09\_2002

**"CITY" CTT 61-2.5 TS**



# CTT 61-2.5

**Diagramma di portata** (I)      **Curbes de charges** (F)      **Curvas de cargas** (E)  
**Load Diagram** (GB)      **Lastkurven** (D)

CTT 61 - 2.5											
		m	5	10	15	20	25	30	35	40	45
2.5 t	- 20.6 m	t	2.5	2.5	2.5	2.5	2.01	1.63	1.36	1.16	1
2.5 t	- 24.14 m	t	2.5	2.5	2.5	2.5	2.4	1.96	1.64	1.4	
2.5 t	- 26.19 m	t	2.5	2.5	2.5	2.5	2.5	2.15	1.8		
2.5 t	- 26.77 m	t	2.5	2.5	2.5	2.5	2.5	2.2			
2.5 t	- 25 m	t	2.5	2.5	2.5	2.5	2.5				

**Altre installazioni** (I)      **Autres implantations** (F)      **Otras implantaciones** (E)  
**Other configurations** (GB)      **Aufstellmöglichkeiten** (D)

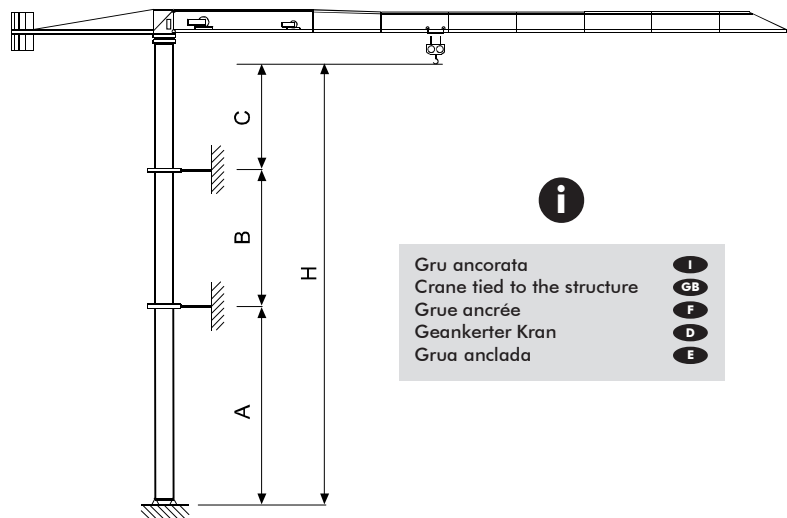



# CTT 61-2.5

Torre **I**  
Mast **GB**

Mât **F**  
Turm **D**

Mástil **E**

## TS12

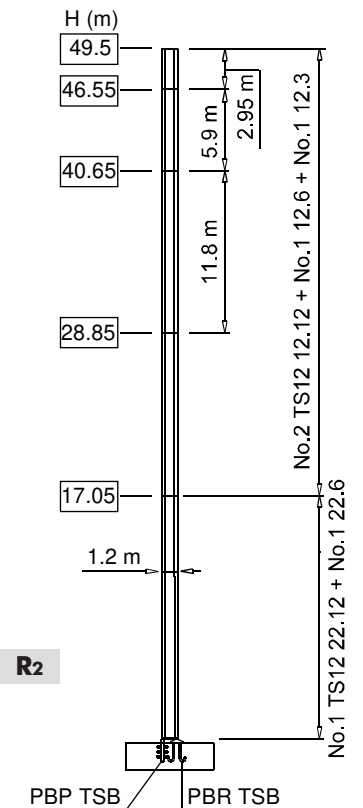
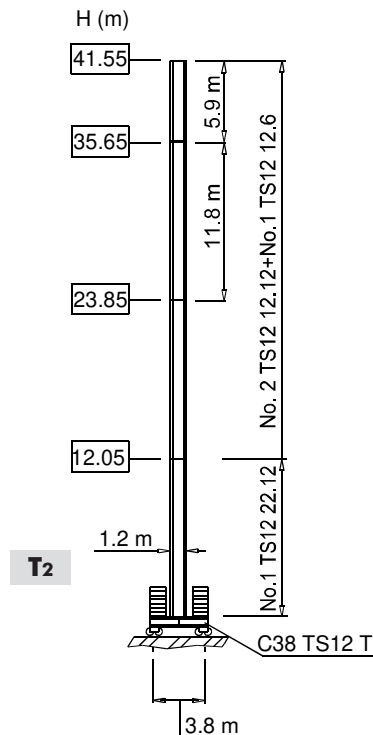
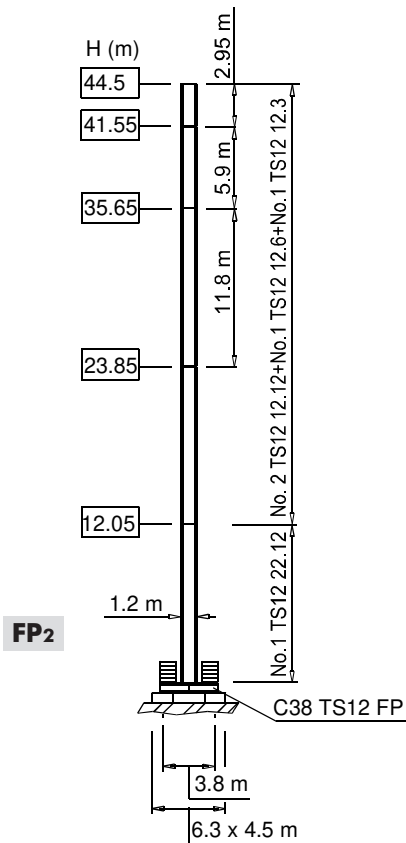
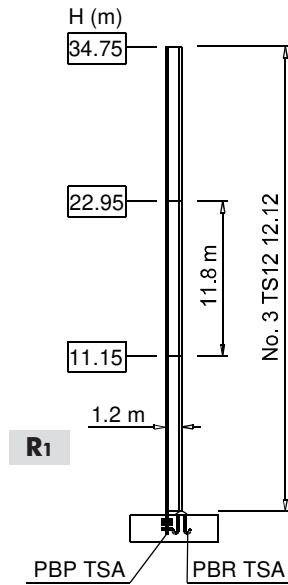
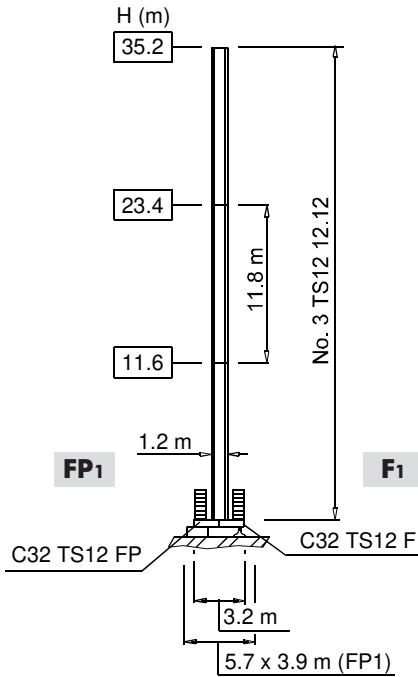

- I** Le prolunghe TS sono disponibili in lunghezze 11.8 m, 5.9 m, 2.95 m.
- GB** The available lengths for the TS tower sections are 11.8 m, 5.9 m, 2.95 m.
- F** Les éléments de mât TS sont disponibles en longueur 11.8 m, 5.9 m, 2.95 m.
- D** Die Turmschüsse TS sind mit Längen 11.8 m, 5.9 m, 2.95 m verfügbar.
- E** Los tramos de torre TS son disponibles en las medidas de largo 11.8 m, 5.9 m, 2.95 m.



# CTT 61-2.5

**Meccanismi**  
**Mechanisms**



**Mécanismes**  
**Antriebe**



**Mecanismos**



11 APC 25	29 * kVA	400 V - 50 Hz	CE 87/405
15 AFC 25	38 * kVA	400 V - 50 Hz / 460 V - 60 Hz	

\* Gru senza traslazione / Crane without travelling equipment / Grue sans translation / Krane ohne Schienenfahren / Grúa sin traslación

		m/min	t	kW	
	<b>11 APC 25</b>	6	2.5	11	186 m
		20	2.5		
		40	1.25		
	<b>15 AFC 25 (VARIANT)</b>	0 ⇌ 1.7	2.5	15	186 m
		1.7 ⇌ 6	2.5		
		6 ⇌ 28	2.5		
		28 ⇌ 46	1.44		
		46 ⇌ 57	1.1		

400 v - 50 hz			
	<b>DAD 2 2</b>	0 - 22 - 44 m/min	2.2-1.5 kW
	<b>DVF 3 2 (VARIANT)</b>	0 ⇌ 5 ⇌ 27 ⇌ 54 m/min	2.2 kW
	<b>SSR 1 1 50</b>	0 ⇌ 0.87 r.p.m.	1 x 50 Nm
	<b>TAD 1RP 2M3</b>	0 - 24 m/min	2 x 3 kW

	Sollevamento	<b>I</b>	Hoisting	<b>GB</b>	Levage	<b>F</b>	Heben	<b>D</b>	Elevación	<b>E</b>
	Traslazione carrello		Trolleying		Distribution		Katzfahren		Distribución	
	Rotazione		Slewing		Orientation		Schwenken		Orientación	
	Traslazione		Travelling		Translation		Schienenfahren		Traslación	
	Direttiva sul livello acustico		Directive on noise level		Directive sur le niveau acoustique		Richtlinie für den Schall-Leistungspegel		Directiva sobre el nivel acustico	
	Consultateci		Consult us		Nous consulter		Auf Anfrage		Consultarnos	
	Potenza totale richiesta		Power requirements		Puissance totale nécessaire		Geforderte Stromstärke		Potencia necesaria	
	Alimentazione		Power supply		Alimentation		Stromversorgung		Alimentación	

## Gru Comedil s.r.l.

A Terex Company

Via S. Egidio 42/A, 33074 Fontanafredda (PN) - Italy  
Tel. (+39) 0434 567 311 - Telefax (+39) 0434 998631

Internet e-mail: [info@comedil.com](mailto:info@comedil.com)  
Internet home page: <http://www.comedil.com>

Terex Internet home page: <http://www.terex.com>

## Divisione Automontanti

Via Alessandrina, 25 - 20095 Cusano Milanino (MI) - Italy  
Tel. (+39) 02 613 16011 - Telefax (+39) 02 613 16034

Internet e-mail: [info.CBR@comedil.com](mailto:info.CBR@comedil.com)

